

PHILIPS

Lighting

Tailored creations



Spotlight MS-M T







A custom configured 3D
printed solution

Project notes

CUSTOMER
PROJECT
DATE

Finish options

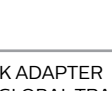
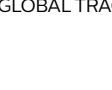
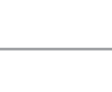
3D PRINTED UV-STABILIZED POLYCARBONATE PLASTIC WITH DECORATIVE LAYERED TEXTURE

COLOR	TEXTURE		COLOR	TEXTURE	
WH401 SATIN WHITE (9003)	LAYERED FINE T102A		BL410 METALLIC BLUE	LAYERED FINE T102A	
SI400 SATIN SILVER	LAYERED FINE T102A		GN410 METALLIC GREEN	LAYERED FINE T102A	
BK402 SATIN BLACK (9004)	LAYERED FINE T102A		GO400 SATIN GOLD	LAYERED FINE T102A	
GR403 SATIN DARK GREY (7043)	LAYERED FINE T102A		PK410 ROSE GOLD (METALLIC PINK)	LAYERED FINE T102A	
GR402 SATIN GREY (9006)	LAYERED FINE T102A		PU410 METALLIC PURPLE	LAYERED FINE T102A	

Mounting

DESCRIPTION	DRIVER IN TRACK ADAPTER DESIGNED FOR GLOBAL TRACK	
FIXTURE WEIGHT	0.65kg	
ROTATION	340°	
TILT	90°	

Electrical

INPUT VOLTAGE	220-240vac
FREQUENCY	50-60hz
POWER FACTOR	0.9
DRIVER FAIL RATE	<1% @ 5,000hrs
CONTROL	PSU / PSD

Operational & certifications

PROTECTION CLASS	IP20, IK02, Electrical Class II
AMBIENT RANGE	TAMBIENT RANGE: +10° to +35°
CERTIFICATIONS	CE, RoHS
GLOW WIRE TEST	650°
WARRANTY	5 YEARS

Optical

DESCRIPTION	PHILIPS COB WITH ALUMINIUM COATED REFLECTOR WITH A PLASTIC BASE
LIFETIME	50,000hrs to L80/B50 @ 25° C
SYSTEM LUMENS	UP TO 4200

LIGHT RECIPES		BEAM	CLEAR LENS*
2700K fresh food champagne	CRI 80+	NB MB WB VWB OVL-H OVL-V	Yes / No *Not available in combination with OVL-H / OVL-V
3000K	CRI 80+		
4000K fresh food frost	CRI 80+		
PremiumWhite 3000K	CRI 90+		
PremiumWhite 4000K	CRI 90+		
PremiumColor 3000K	CRI 90+		
Fresh Food Meat (FMT)			
Rose			

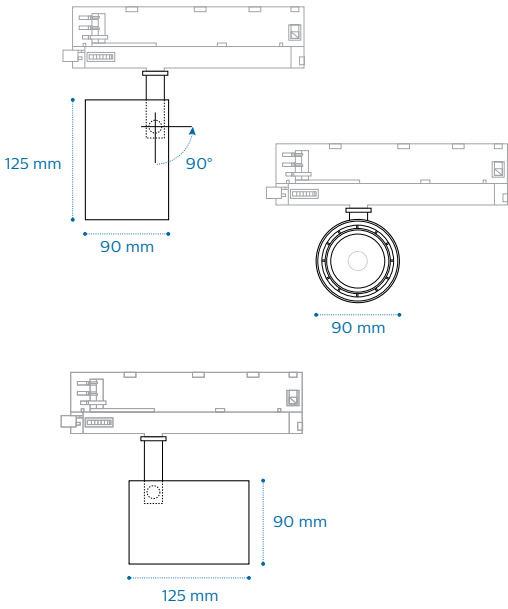

PRODUCT DESCRIPTION	BEAM	SYSTEM POWER [W] +-10%	WITHOUT CLEAR LENS		WITH CLEAR LENS	
			SYSTEM FLUX [lm] +-10%	SYSTEM EFFICACY [lm/W] +-10%	SYSTEM FLUX [lm] +-10%	SYSTEM EFFICACY [lm/W] +-10%
MS-M T 17S/827 PSU / PSD	NB	15	1573	105	1511	101
	MB	14	1769	126	1700	121
	WB	14	1749	124	1680	119
	VWB	14	1769	126	1700	121
MS-M T 17S/830 PSU / PSD	NB	15	1638	109	1574	105
	MB	14	1845	131	1773	126
	WB	14	1824	129	1752	124
	VWB	14	1845	131	1773	126
MS-M T 17S/840 PSU / PSD	NB	15	1738	116	1670	111
	MB	14	1921	136	1845	131
	WB	14	1899	135	1824	129
	VWB	14	1921	136	1845	131
MS-M T 17S/PW930HE PSU / PSD	NB	21	1989	95	1911	92
	MB	14	1700	123	1633	118
	WB	14	1681	121	1614	117
	VWB	14	1681	121	1614	117
MS-M T 17S/PW940HE PSU / PSD	NB	21	2125	102	2042	98
	MB	14	1806	130	1735	125
	WB	14	1786	129	1715	124
	VWB	14	1786	129	1715	124
MS-M T 17S/PC930HE PSU / PSD	NB	21	1848	89	1775	85
	MB	14	1549	112	1488	108
	WB	14	1531	111	1470	106
	VWB	14	1531	111	1470	106
MS-S T 17S/FMT PSU / PSD	MB	23	1908	82	1833	78
	WB	23	1886	81	1811	77
	VWB	23	1886	81	1811	77
MS-S T 17S/Rose PSU/PSD	MB	20	1896	94	1821	90
	WB	20	1874	93	1800	89
	VWB	20	1896	94	1821	90
MS-M T 23S/827 PSU / PSD	NB	22	2136	98	2052	94
	MB	20	2457	123	2360	118
	WB	20	2429	122	2332	117
	VWB	20	2457	123	2360	118
MS-M T 23S/830 PSU / PSD	NB	22	2167	99	2082	96
	MB	20	2559	128	2459	123
	WB	20	2531	127	2430	122
	VWB	20	2559	128	2459	123
MS-M T 23S/840 PSU / PSD	NB	22	2305	106	2214	102
	MB	20	2666	133	2561	128
	WB	20	2636	132	2531	127
	VWB	20	2666	133	2561	128
MS-M T 23S/PW930HE PSU / PSD	NB	30	2452	82	2355	79
	MB	20	2408	123	2313	118
	WB	20	2381	122	2286	117
	VWB	20	2381	122	2286	117
MS-M T 23S/PW940HE PSU / PSD	NB	25	2409	95	2314	91
	MB	20	2559	131	2459	126
	WB	20	2531	129	2430	124
	VWB	20	2531	129	2430	124
MS-M T 23S/PC930HE PSU / PSD	NB	30	2269	76	2180	73
	MB	20	2192	112	2106	108
	WB	20	2168	111	2081	106
	VWB	20	2168	111	2081	106
MS-S T 23S/FMT PSU / PSD	MB	29	2319	79	2228	76
	WB	29	2293	78	2202	75
	VWB	29	2293	78	2202	75
MS-S T 23S/Rose PSU / PSD	MB	29	2509	88	2410	84
	WB	29	2480	87	2382	83
	VWB	29	2509	88	2410	84
MS-M T 27S/827HE PSU / PSD	MB	24	3041	129	2921	124
	WB	24	3006	128	2887	123
	VWB	24	3006	128	2887	123
MS-M T 27S/830HE PSU / PSD	MB	24	3126	133	3003	128
	WB	24	3091	131	2968	126
	VWB	24	3091	131	2968	126
MS-M T 27S/840HE PSU / PSD	MB	19	2792	144	2682	138
	WB	19	2761	142	2651	136
	VWB	19	2761	142	2651	136
MS-M T 27S/PW930HE PSU / PSD	MB	24	2845	121	2733	116
	WB	24	2813	120	2701	115
	VWB	24	2813	120	2701	115

MS-M T 27S/PW940HE PSU / PSD	MB	24	3030	129	2911	124
	WB	24	2996	127	2877	122
	VWB	24	2996	127	2877	122
MS-M T 27S/PC930HE PSU / PSD	MB	24	2590	110	2488	106
	WB	24	2561	109	2459	105
	VWB	24	2561	109	2459	105
MS-S T 27S/FMT PSU / PSD	MB	36	2696	75	2590	72
	WB	36	2665	74	2559	71
	VWB	36	2665	74	2559	71
MS-S T 27S/Rose PSU / PSD	MB	33	2773	85	2664	81
	WB	33	2742	84	2633	80
	VWB	33	2773	85	2664	81
MS-M T 32S/827HE PSU / PSD	MB	28	3480	126	3343	121
	WB	28	3440	124	3304	119
	VWB	28	3440	124	3304	119
MS-M T 32S/830HE PSU / PSD	MB	28	3578	129	3437	124
	WB	28	3537	128	3397	123
	VWB	28	3537	128	3397	123
MS-M T 32S/840HE PSU / PSD	MB	23	3303	141	3173	136
	WB	23	3266	140	3136	134
	VWB	23	3266	140	3136	134
MS-M T 32S/PW930HE PSU / PSD	MB	28	3258	118	3130	113
	WB	28	3221	116	3093	112
	VWB	28	3221	116	3093	112
MS-M T 32S/PW940HE PSU / PSD	MB	28	3471	125	3334	120
	WB	28	3432	124	3295	119
	VWB	28	3432	124	3295	119
MS-M T 32S/PC930HE PSU / PSD	MB	30	3142	106	3018	102
	WB	30	3107	105	2983	101
	VWB	30	3107	105	2983	101
MS-M T 37S/827HE PSU / PSD	MB	30	3692	125	3546	120
	WB	30	3650	123	3505	119
	VWB	30	3650	123	3505	119
MS-M T 37S/830HE PSU / PSD	MB	30	3796	128	3646	123
	WB	30	3753	127	3604	122
	VWB	30	3753	127	3604	122
MS-M T 37S/840HE PSU / PSD	MB	28	3787	138	3638	132
	WB	28	3744	136	3595	131
	VWB	28	3744	136	3595	131
MS-M T 37S/PW930HE PSU / PSD	MB	32	3640	115	3497	111
	WB	32	3599	114	3456	109
	VWB	32	3599	114	3456	109
MS-M T 37S/PW940HE PSU / PSD	MB	30	3685	125	3540	120
	WB	30	3643	123	3498	118
	VWB	30	3643	123	3498	118
MS-M T 37S/PC930HE PSU / PSD	MB	36	3636	101	3493	97
	WB	36	3595	100	3452	96
	VWB	36	3595	100	3452	96
MS-M T 42S/827HE PSU / PSD	MB	36	4270	119	4102	114
	WB	36	4222	117	4054	113
	VWB	36	4222	117	4054	113
MS-M T 42S/830HE PSU / PSD	MB	36	4391	122	4218	117
	WB	36	4341	121	4169	116
	VWB	36	4341	121	4169	116
MS-M T 42S/840HE PSU / PSD	MB	36	4652	129	4470	124
	WB	36	4600	128	4417	123
	VWB	36	4600	128	4417	123
MS-M T 42S/PW930HE PSU / PSD	MB	36	3996	111	3839	107
	WB	36	3952	110	3794	105
	VWB	36	3952	110	3794	105
MS-M T 42S/PW940HE PSU / PSD	MB	36	4268	118	4100	114
	WB	36	4220	117	4052	112
	VWB	36	4220	117	4052	112

